



# Clear-Com HME DX210

Dual-Channel Wireless Intercom  
Operating Instructions





Copyright © 2017 Clear-Com, LLC, an HM Electronics, Inc. company.

All rights reserved.

Clear-Com, the Clear-Com logo and Clear-Com Concert are trademarks or registered trademarks of HM Electronics, Inc.

The product described in this document is distributed under licenses restricting its use, copying, distribution, and decompilation/reverse engineering. No part of this document may be reproduced in any form by any means without prior written authorization of Clear-Com, an HME Company.

Clear-Com Offices are located in California, USA; Cambridge, UK; Montreal, Canada; and Beijing, China. Addresses and contact information can be found on Clear-Com's corporate website at [www.clearcom.com](http://www.clearcom.com).

## Clear-Com Contacts

### Americas and Asia-Pacific Headquarters

California, United States

Tel: +1.510.337.6600

Email: [CustomerServicesUS@clearcom.com](mailto:CustomerServicesUS@clearcom.com)

### Europe, Middle East, and Africa Headquarters

Cambridge, United Kingdom

Tel: +44 1223 815000

Email: [SalesSupportEMEA@clearcom.com](mailto:SalesSupportEMEA@clearcom.com)

### Canada Office

Quebec, Canada

Tel: +1 (450) 653-9669

### China Office

Beijing Representative Office

Beijing, P.R.China

Tel: (008610)-8528-8748

## FCC NOTICE

This device complies with Part 15 of the FCC rules. Operation is subject to the following two conditions : (1) This device may not cause harmful interference, and (2) This device must accept any interference received, including interference that may cause undesired operation.

**NOTE:** This equipment has been tested and found to comply with the limits for a Class A digital device, pursuant to Part 15 of the FCC rules. These limits are designed to provide reasonable protection against harmful interference when the equipment is operated in a commercial environment. This equipment generates, uses and can radiate radio frequency energy and, if not installed and used in accordance with the instruction manual, may cause harmful interference to radio communication. Operation of this equipment in a residential area is likely to cause harmful interference, in which case the user will be required to correct the interference at his own expense.

Changes or modifications not expressly approved by Clear-Com, LLC, an HM Electronics, Inc. company could void the user's authority to operate this equipment.

## MANDATORY SAFETY INSTRUCTIONS FOR INSTALLERS AND USERS

Use only manufacturer or dealer supplied antennas. The Federal Communications Commission has adopted a safety standard for human exposure to RF (Radio frequency) energy, which is below the OSHA (Occupational Safety and Health Act) limits.

The term "IC:" before the certification/registration number only signifies that the Industry Canada technical specifications were met.

**Base Station Antenna minimum safe distance:** 7.9 inches (20 cm) at 100% duty cycle.

**Base Station Antenna gain:** This device has been designed to operate with an antenna having a maximum gain of up to 7dBi.

**Antenna mounting:** The antenna(s) used for the base transmitter must be installed to provide a separation distance of at least 7.9 inches (20 cm) from all persons and must not be co-located or operating in conjunction with any other antenna or transmitter.

**Antenna substitution:** Do not substitute any antenna for the one supplied by the manufacturer. You may be exposing person or persons to excess radio frequency radiation. You may contact your dealer or the manufacturer for further instructions.

**WARNING:** Maintain a separation distance from the base station transmit antenna to a person(s) of at least 7.9 inches (20 cm) at 100% duty cycle.

**WARNING:** Excessive sound pressure level from earphones or headphones can cause hearing loss.

You, as the qualified end-user of this radio device must control the exposure conditions of bystanders to ensure the minimum separation distance (above) is maintained between the antenna and nearby persons for satisfying exposure compliance. The operation of this transmitter must satisfy the requirements of Occupational /Controlled Exposure Environment, for work-related use. Transmit only when person(s) are at least the minimum distance from the properly installed, externally mounted antenna.

Clear-Com, LLC, an HM Electronics, Inc. company, is not responsible for equipment malfunctions due to erroneous translation of its publications from their original English version. Illustrations in this publication are approximate representations of the actual equipment, and may not be exactly as the equipment appears.

Hereby, Clear-Com, LLC, an HM Electronics, Inc, company, declares that the DX210 is in compliance with the essential requirements and other relevant provisions of R&TTE Directive 1999/5/EC.



This product operates in the 2400 to 2483.5 MHz frequency range. The use of this frequency range is not yet harmonized between all countries. Some countries may restrict the use of a portion of this band or impose other restriction relating to power level or use. You should contact your Spectrum authority to determine possible restrictions.

### WASTE ELECTRICAL AND ELECTRONIC EQUIPMENT (WEEE)

The European Union (EU) WEEE Directive 2012/19/EU places an obligation on producers (manufacturers, distributors and/or retailers) to take-back electronic products at the end of their useful life. The WEEE Directive covers most Clear-Com products being sold into the EU as of August 13, 2005. Manufacturers, distributors and retailers are obliged to finance the costs of recovery from municipal collection points, reuse, and recycling of specified percentages per the WEEE requirements.

### Instructions for Disposal of WEEE by Users in the European Union

The symbol shown below is on the product or on its packaging which indicates that this product was put on the market after August 13, 2005 and must not be disposed of with other waste. Instead, it is the user's responsibility to dispose of the user's waste equipment by handing it over to a designated collection point for the recycling of WEEE. The separate collection and recycling of waste equipment at the time of disposal will help to conserve natural resources and ensure that it is recycled in a manner that protects human health and the environment. For more information about where you can drop off your waste equipment for recycling, please contact your local authority, your household waste disposal service or the seller from whom you purchased the product.



---

**Korea:** 해당 무선설비는 전파혼신 가능성이 있으므로 인명안전과 관련된 서비스는 할 수 없음

**Singapore:**

Complies with  
IDA Standards  
DA10582

**Taiwan:**

注意!

依據低功率電波輻射性電機管理辦法第十二條經型式認證合格之低功率射頻電機，非經許可，公司、商號或使用者均不得擅自變更頻率、加大功率或變更原設計之特性及功。

第十四條低功率射頻電機之使用不得影響飛航安全及干擾合法通信；經發現有干擾現象時，應立即停用，並改善至無干擾時方得繼續使用。前項合法通信，指依電信規定作業之無線電信。低功率射頻電機須忍受合法通信或工業、科學及醫療用電波輻射性電機設備之干擾。

# Contents

<b>1</b>	<b>System Overview</b>	<b>1</b>
1.1	System Components	1
1.2	Base Station Front Panel	2
1.3	Base Station Rear Panel	2
1.4	Beltpack – BP210	3
1.5	All-In-One Headset – WH220	3
<b>2</b>	<b>System Setup</b>	<b>4</b>
2.1	Battery Charging	4
2.1.1	Connect AC40 Power Supply	4
2.1.2	Charge Batteries	4
2.1.3	Connect AC50 Power Supply	6
2.1.4	Charge Batteries	6
2.2	Basic Base Station Setup	7
2.3	Beltpack and All-in-One Headset Setup and Registration	8
2.3.1	Set Up Beltpack and All-in-One Headset	8
2.3.2	Register Beltpacks and All-in-One Headsets	9
2.3.3	Beltpacks and All-in-One Headset Settings	10
2.4	Interfacing with 2-Wire or 4-Wire Intercoms	11
2.5	Interfacing with Auxiliary Audio Equipment	12
2.6	ISO Relay	13
<b>3</b>	<b>System Operation</b>	<b>14</b>
3.1	Base Station Operation	14
3.1.1	Digital Radio Controls and Indicator Lights	14
3.1.2	Local Headset Connector, Controls and Indicator Lights	14
3.2	Beltpack and All-in-One Headset Operation	15
3.2.1	Power On/Off	15
3.2.2	ISO (Isolate) and IC1, IC2 (Intercom)	15
3.2.3	Operating Modes	15
3.2.4	Volume Up/Down	15
3.2.5	Adjusting Microphone Gain	16
3.2.6	Adjusting BP210 Beltpack Side Tone	16
3.2.7	Using WH220 All-In-One Headset Lights-Off Mode	16
3.2.8	Changing Batteries	16
<b>4</b>	<b>Troubleshooting</b>	<b>17</b>
<b>5</b>	<b>Technical Data</b>	<b>18</b>
5.1	BS210 Base Station Specifications	18
5.2	BP210 Beltpack Specifications	19
5.3	WH220 All-In-One Headset Specifications	20
<b>Appendix A:</b>	<b>Indicator Light Functions</b>	<b>21</b>
<b>Appendix B:</b>	<b>Multiple Base Station Daisy-Chaining</b>	<b>22</b>
<b>Appendix C:</b>	<b>Jumper Settings</b>	<b>23</b>
<b>Appendix D:</b>	<b>Multiple Base Station Registration</b>	<b>24</b>
<b>Appendix E:</b>	<b>Interference Avoidance through Spectrum Friendly</b>	<b>26</b>
<b>Appendix F:</b>	<b>Adaptive Frequency Hopping</b>	<b>28</b>
<b>Appendix G:</b>	<b>Audio Routing Diagram</b>	<b>31</b>
<b>Appendix H:</b>	<b>Appendix G: DX Series LED Aid</b>	<b>32</b>

# 1 System Overview

The Clear-Com® HME DX210 is a 2-channel Digital Wireless Intercom System that supports up to 15 beltpacks or all-in-one headsets per base station (any combination of Beltpacks or All-In-One Headsets). Using the DX210 in the 2-channel mode, any 3 of the 15 beltpacks and all-in-one headsets can transmit simultaneously. In the single-channel mode, any 4 Beltpacks or all-in-one headsets can transmit simultaneously. This number can be increased by connecting up to 3 additional base stations. The DX210 has 4-wire and auxiliary audio connections and supports both Clear-Com and RTS cabled 2-wire intercom systems.

The DX210 operates in the 2.4GHz band and has provisions for “Spectrum Friendly” co-existence with other devices in the same band.

## 1.1 System Components

### BS210 Base Station:



**Antennas:**



**110/240 Switching Power Supply:**



**BP210 Beltpack:**



**Headset:**



and/or

**WH220 All-In-One Headset:**



**Beltpack Pouch:**



**BAT41 battery and AC40 Battery Charger with power supply**



Used for charging BP210 batteries.

**BAT50 battery and AC50 Battery Charger with 110/240 Switching Power Supply**



Used for charging WH220 wireless headset batteries



## 1.2 Base Station Front Panel

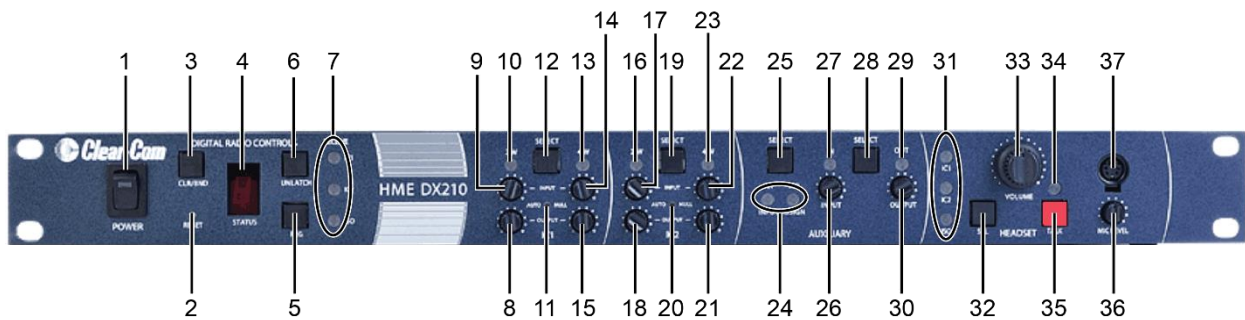

### DIGITAL RADIO CONTROLS

1. POWER switch
2. RESET button (recessed)
3. CLR/BND button
4. STATUS display
5. REG (registration) button
6. UNLATCH button
7. RECEIVE indicator lights

### IC1 CONTROLS

8. IC1 2-W output level adjust
9. IC1 2-W input level adjust
10. IC1 2-W indicator light
11. IC1 AUTO NULL button (recessed)
12. IC1 2-W/4-W SELECT button
13. IC1 4-W indicator light
14. IC1 4-W input level adjust
15. IC1 4-W output level adjust

### IC2 CONTROLS

16. IC2 2-W indicator light
17. IC2 2-W input level adjust
18. IC2 2-W output level adjust

19. IC2 2-W/4-W SELECT button
20. IC2 AUTO NULL button (recessed)
21. IC2 4-W output level adjust
22. IC2 4-W input level adjust
23. IC2 4-W indicator light

### AUXILIARY CONTROLS

24. AUX IC1/IC2 INPUT ASSIGN indicators
25. AUX INPUT ASSIGN button
26. AUX INPUT level adjust
27. AUX IN indicator light
28. AUX INPUT/OUTPUT SELECT button
29. AUX OUT indicator light
30. AUX OUTPUT level adjust

### HEADSET CONTROLS

31. HEADSET IC1, IC2 & ISO indicator lights
32. HEADSET IC1, IC2 & ISO SELECT button
33. HEADSET VOLUME knob
34. HEADSET TALK indicator light
35. HEADSET TALK On/Off button
36. HEADSET MIC LEVEL adjust
37. HEADSET cable connector

## 1.3 Base Station Rear Panel

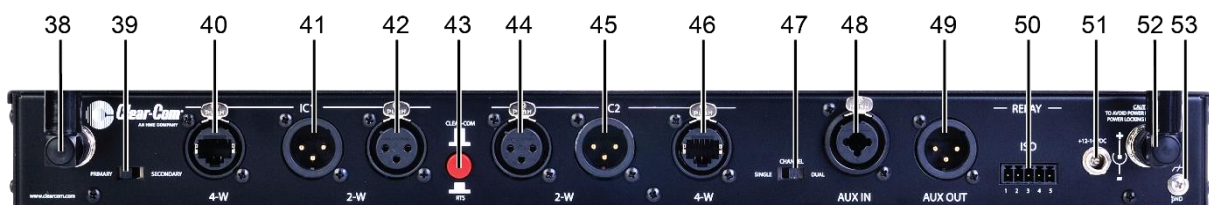

38. ANT (R-TNC)
39. PRIMARY/SECONDARY Select Switch
40. IC1 4-W RJ-45 Connector
41. IC1 2-W XLR-3M Connector
42. IC1 2-W XLR-3F Connector
43. CLEAR-COM/RTS Select Switch
44. IC2 2-W XLR-3F Connector
45. IC2 2-W XLR-3M Connector

46. IC2 4-W RJ-45 Connector
47. SINGLE/DUAL Channel Select Switch
48. AUX IN Connector
49. AUX OUT Connector
50. Relay Connector
51. DC Power Connector
52. ANT (R-TNC)
53. Chassis Grounding Screw



## 1.4 Beltpack – BP210



1. Headset cable connector
2. Power/mode lights
3. IC2 (Intercom 2) button
4. ISO (Isolate) button
5. IC1 (Intercom 1) button

6. PWR (Power) button
7. Volume-up button
8. Volume-down button
9. Battery
10. Battery-release latch

## 1.5 All-In-One Headset – WH220

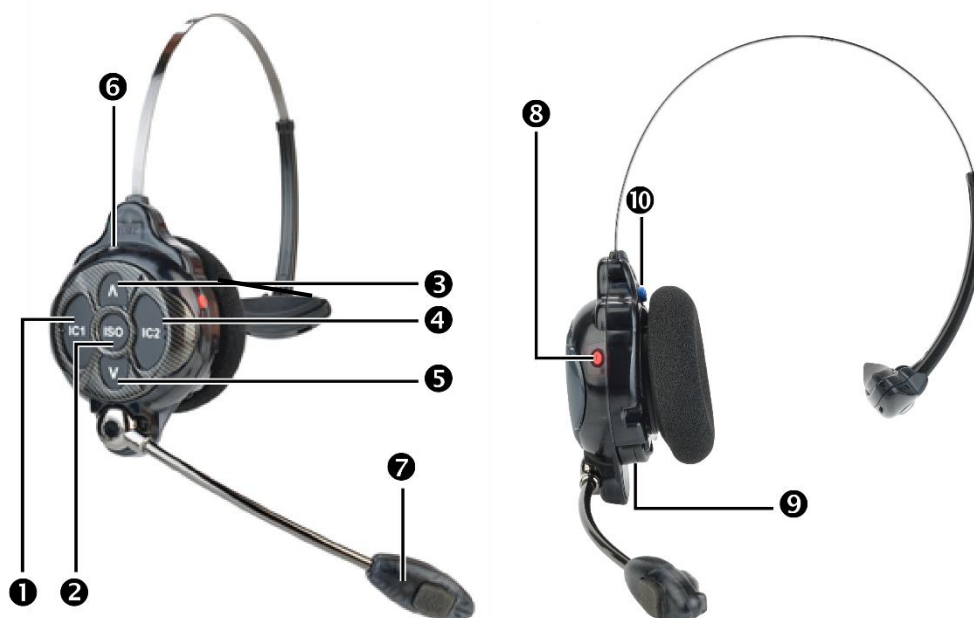

1. IC1 button
2. ISO (Isolate) button
3. Volume-up button
4. IC2 button
5. Volume-down button

6. Power/mode light
7. Microphone
8. Power button
9. Battery
10. Battery-release latch

# 2 System Setup

This chapter describes how to set up and configure the DX210.

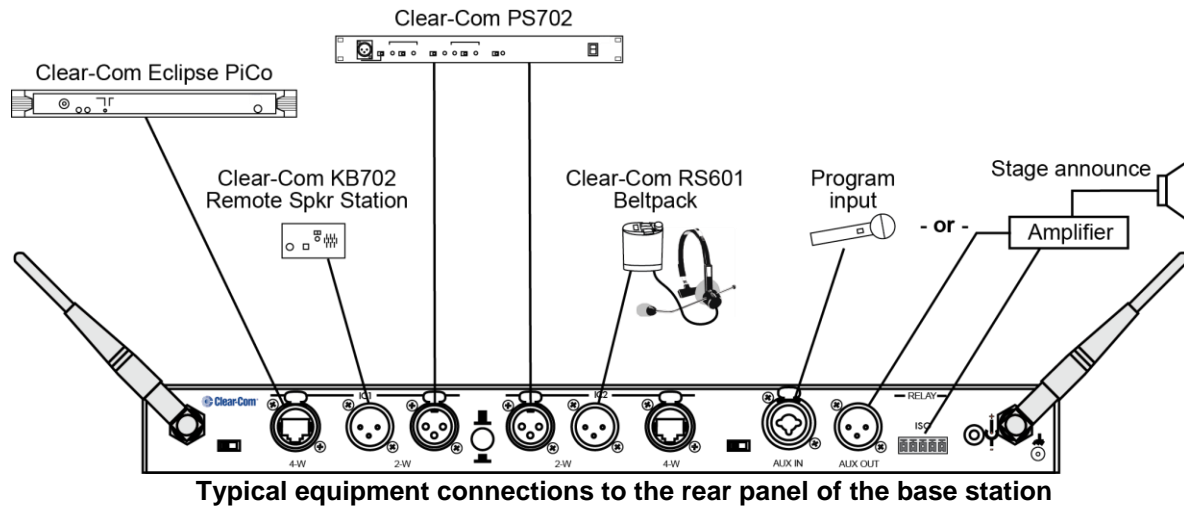

## 2.1 Battery Charging

Before installing the system, connect the AC power supply to the battery charger and plug it into an electrical outlet. Charge all the batteries while the other equipment is being installed. Charging time is about 2.5 hours.

### 2.1.1 Connect AC40 Power Supply

To connect the AC power supply to the battery charger:

- Connect the AC power supply cable connector to the power connection on the battery charger and turn clockwise to lock in place.
- Connect the AC power cord connector to the AC power supply unit.
- Connect the AC power cord to an electrical outlet.

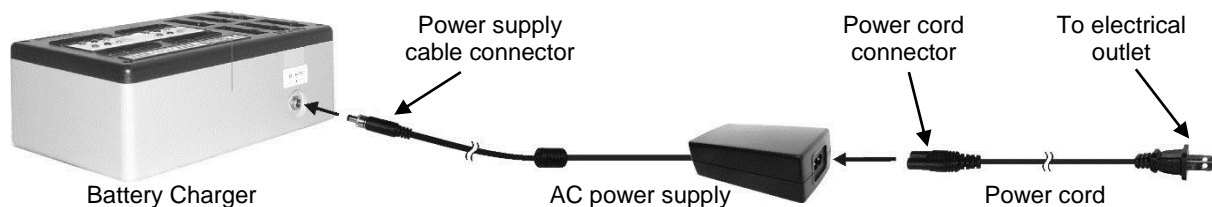

The red lights on the charger will come on briefly, and then the yellow lights will come on and stay on.

### 2.1.2 Charge Batteries

Up to four batteries can be charged in the battery charger at the same time. The battery status lights next to each charging port are explained below. Up to six fully charged batteries can be stored in the battery storage ports.

- Insert a battery in each of four charging ports until it clicks in place.
- A yellow light next to each charging port stays on while the port is empty. When a battery is in a charging port, a flashing yellow light next to it indicates CHARGE PENDING, which means the battery is too hot. Adjust the room temperature or move the charger to a cooler area. When a battery is in a charging port, a yellow light on steady next to it means CHARGE FAILED. If this happens, follow the instructions on the side of battery charger.
- A red CHARGING light next to a battery port stays on while a battery in the port is charging.
- A green READY light next to a battery port goes on when a battery in the port is fully charged.
- Store fully charged batteries in storage ports.

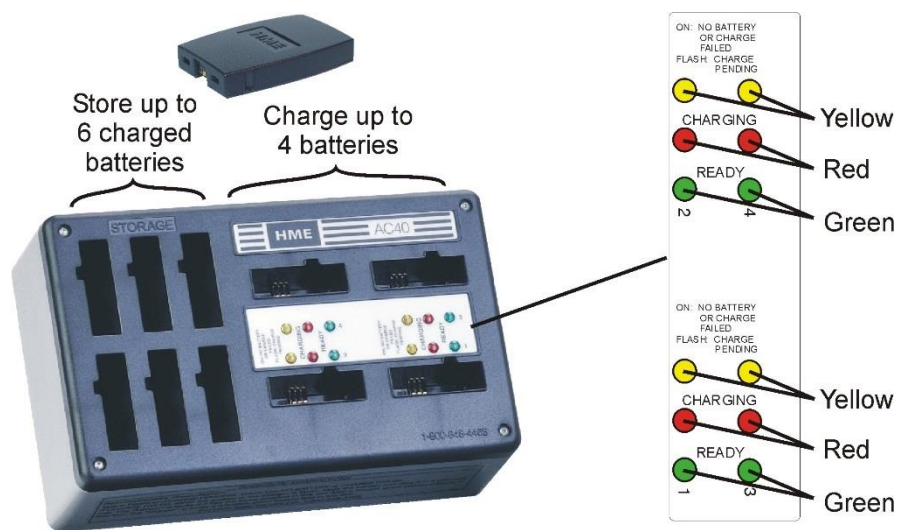

**NOTE:** Batteries should not be left in charge ports after being fully charged. If a battery is left in a charge port for more than three weeks, the yellow indicator may light up. In this case, it does not indicate a faulty battery.

### 2.1.3 Connect AC50 Power Supply

To connect the AC power supply to the battery charger:

1. Connect the AC power supply cable connector to the power connection on the battery charger.
2. Connect the AC power cord to an electrical outlet.

The red lights on the charger will briefly display, and then the yellow lights will appear and remain on.



### 2.1.4 Charge Batteries

Up to four batteries can be charged in the battery charger at one time. The battery status lights next to each charging port indicate the battery status. Up to four fully charged batteries can be stored in the battery Storage ports. Insert a battery in each of four Charging ports until it clicks in place.

- A yellow light next to a Charging port indicates that the port is **EMPTY**.
- A red light next indicates that the battery port is **CHARGING**.
- A green light indicates that the battery is **READY**.
- A steady yellow light indicates that the **CHARGE FAILED**. If a charge fails, refer to the instructions on the side of battery charger.
- A flashing yellow light next indicates **CHARGE PENDING**, which means the inserted battery is too hot. Adjust the room temperature or move the charger to a cooler area.
- Store fully charged batteries in storage ports.

**IMPORTANT:** Batteries should not be left in charge ports after being fully charged. A battery left in a charging port for more than three weeks may display the yellow indicator light, but it does not indicate a faulty battery.

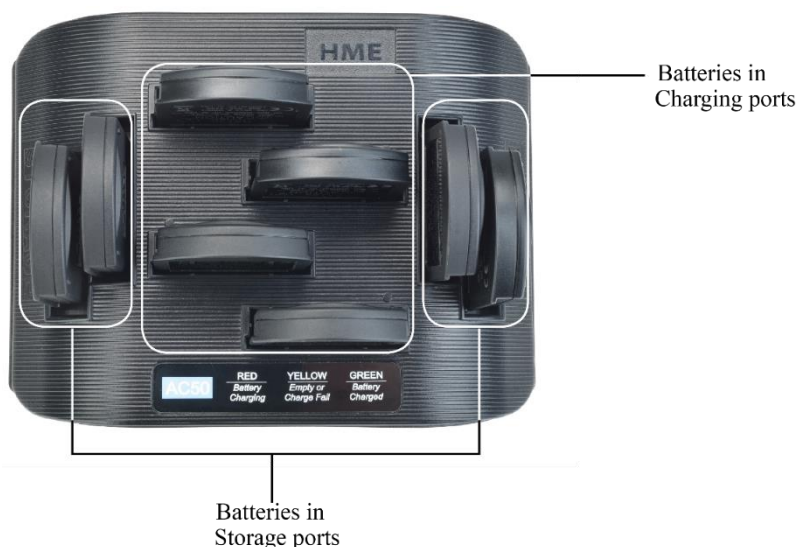

## 2.2 Basic Base Station Setup

This section describes setup and equipment connections for an individual base station.

- Connect the two enclosed antennas to the antenna connectors (#38 and #52) on the rear panel of the base station, and turn the sleeves clockwise on the antenna connectors to tighten them securely in place. Position the antennas at 90° angles from each other.

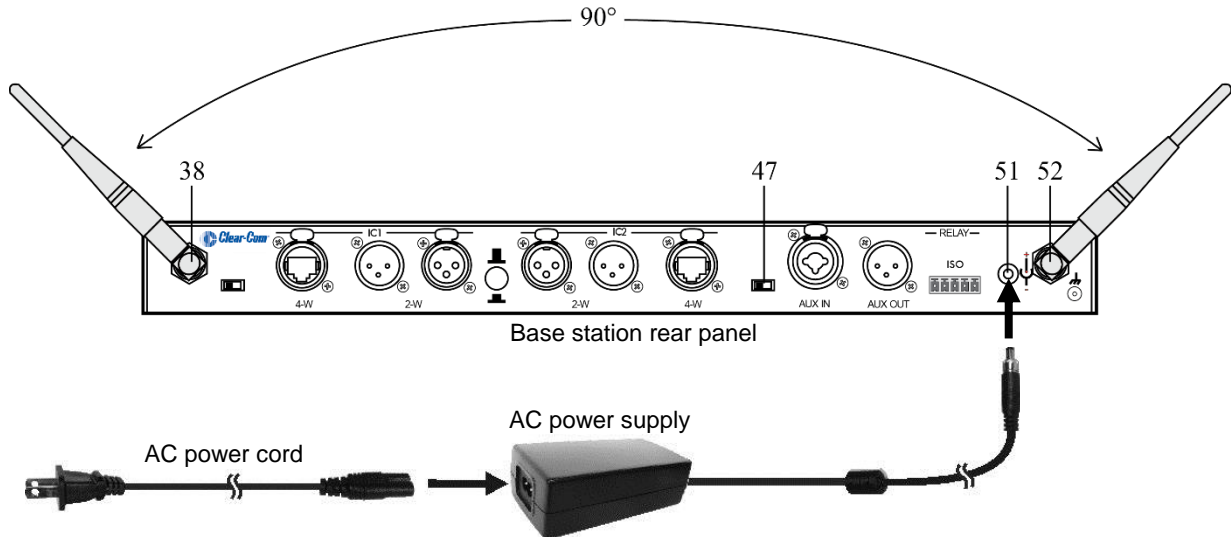

- Plug the connector at the end of the AC power supply cord into the **+12-14VDC** power connector (#51) on the rear panel of the base station. Turn the locking nut on the cable connector clockwise to secure it to the base station. Plug the female connector at one end of the AC power cord into the power supply. Plug the other end of the AC power cord into an electrical outlet.
- Set switch #47 for the base station to operate in single or dual channel mode.  
**In single channel mode**, all wireless users will be able to hear one other. Up to four users can talk simultaneously.  
**In dual channel mode**, there are two separate audio channels enabling two groups of users to independently communicate with each other. Up to three users can talk simultaneously.  
**NOTE:** Any time the mode is changed, the unit must be reset using the reset button or by power cycling for the change to take effect.

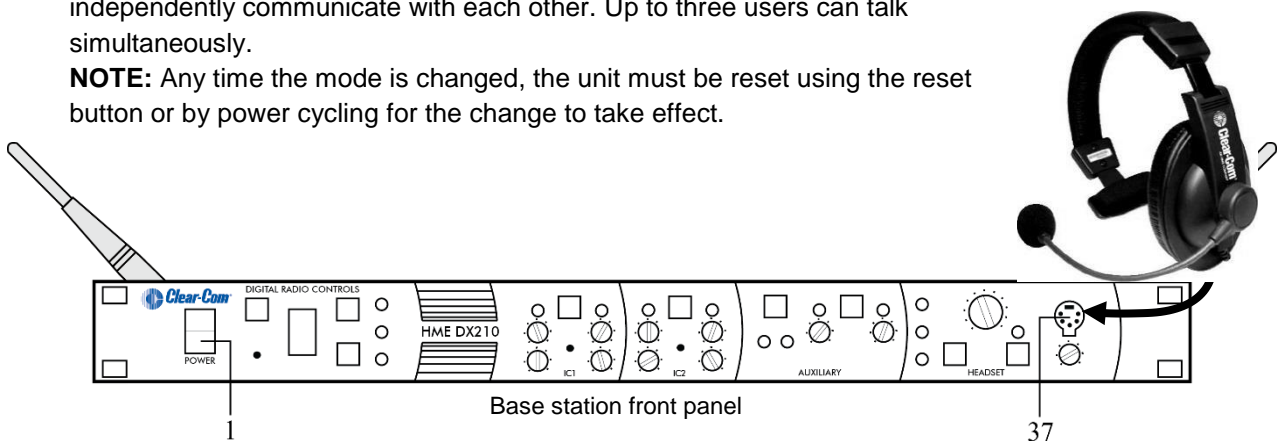

- If a local headset will be used, plug it into the **HEADSET** connector (#37) on the front panel of the base station.  
**NOTE:** The connector is keyed, so the headset cable plug cannot be inserted in the wrong direction.
- Press the **POWER** switch (#1) on the front panel to turn on the base station. A red light on the switch should go on.

If you have more than one base station, refer to [Appendix D, page 24](#) for multiple base station registration.

## 2.3 Beltpack and All-in-One Headset Setup and Registration

The first time you operate the DX210 system, you must register each Beltpack and/or All-In-One Headset for use with a specific base station. The base station will then recognize all powered on, registered beltpacks and all-in-one headsets and will differentiate between them and other electronic equipment operating on the same frequencies. If another is added or replaced later, the new one must be registered and the old one remains in memory. A maximum of 15 beltpacks and all-in-one headsets can be registered to a single base station at one time.

### 2.3.1 Set Up Beltpack and All-in-One Headset

**NOTE:** If multiple base stations will be used or if interference is present, such as Wi-Fi interference, refer to [Base Station Registration](#) and [Interference Avoidance](#) in Appendix D and E on pages 24 through 26.

Before registration, set up all beltpacks and all-in-one headsets as follows:

#### Beltpacks

1. Insert a fully charged battery in each Beltpack, with the metal contacts on the end of the battery inserted first. Press it in until it snaps.
2. Place each Beltpack in a pouch.
3. Plug its headset cable connector into each Beltpack.



#### All-In-One Headsets

Insert a fully charged battery in each Headset. Press it in until it snaps.





## 2.3.2 Register Beltpacks and All-in-One Headsets

The beltpack or all-in-one headset must be within 6 feet (1.83 meters) of the base station to enable registration.

1. **Be sure each beltpack and all-in-one headset to be registered is turned off** and the base station power is on before you begin. Beltpacks and all-in-one headsets that are already registered can be on or off.
2. Put the headset on your head.
3. Press the **REG** button on the front panel of the base station. The **STATUS** display will show a small “o” for open.
4. **NOTE:** If you wait too long before proceeding to the next step, the base station will exit registration mode, and you will have to repeat **step 3**.

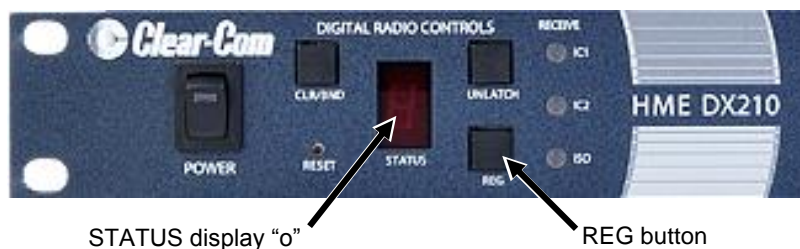

5. Press and hold the **ISO** button on the beltpack or all-in-one headset while pressing and releasing the **PWR** (power) button to turn the unit on, then release the **ISO** button. This will cause the beltpack or all-in-one headset to enter the registration mode.

**On Beltpacks**, the two power lights at the corners near the **IC1** and **IC2** buttons will begin blinking red, then blink green two or three times and turn off. **Wait!** There may be a short delay.

**On All-In-One Headsets**, the power/mode lights will blink. **Wait!** There may be a short delay.

### If registration is successfully completed:

- A voice message in the headset will say “Power on, Beltpack #, Version #, Begin registration, Registration complete, ...”
- After a delay of about 15 seconds, the **STATUS** display will show the ID number assigned to this beltpack or all-in-one headset for about 10 seconds.  
**NOTE:** ID numbers are assigned sequentially as 0 thru 9, A, b, C, d and E.
- The power light on the beltpack or all-in-one headset will remain on steady green.

Repeat Steps **2** to **4** above for each beltpack or all-in-one headset to be registered.

### If registration failed:

- A voice message in the headset will say “Power on, Beltpack #, Version #, Begin registration, ...” Both lights on the Beltpack will blink red, and there may be a delay of up to 90 seconds before you hear “Registration failed”.
- Press the **RESET** button at the lower-left corner of the base station with a pen or similar pointed object. When the **STATUS** display becomes blank, press the **REG** button and register the beltpack or all-in-one headset again. If registration fails again, call your dealer for assistance.

**If you try to register more than 15 beltpacks and all-in-one headsets:**

- An **F** will appear on the **STATUS** display on the base station and you will hear “Registration failed” in the headset.
- Clear all current registrations by pressing the **CLR/BND** button and the **RESET** button simultaneously. To press the **RESET** button, insert a pen or similar pointed object into the **RESET** hole at the lower-left corner of the base station front panel. Continue holding the **CLR/BND** button after you release the **RESET** button, until the clear code “c” (lower case) appears on the **STATUS** display.
- Register all active beltpacks and all-in-one headsets, one at a time. Previously registered beltpacks and all-in-one headsets must be re-registered.

### 2.3.3 Beltpacks and All-in-One Headset Settings

If you want to set up a beltpack or all-in-one headset with any of the special settings shown below, press and hold the specified button combinations during or after power up. These settings will remain in memory when the beltpacks and all-in-one headsets are turned off and on again.

For Setting	Press & Hold while you Press & Release the Power button
ISO restrict on	<b>IC1</b> button
ISO restrict off	<b>IC1</b> and <b>ISO</b> buttons
Handsfree on selected button(s)	<b>IC1</b> and/or <b>IC2</b> and/or <b>ISO</b> and ▲ volume up buttons
Handsfree off selected button(s)	<b>IC1</b> and/or <b>IC2</b> and/or <b>ISO</b> and ▼ volume down buttons
Listen-Only mode on	▼ volume down button
Listen-Only mode off	▲ volume up button
<b>WH220 only *</b> All-In-One Headset “lights-off” mode	<b>IC2</b> button

\* **NOTE:** All-In-One Headsets can be set up with its indicator lights off, to avoid distraction if users are in an area visible to audience. This setting is not saved when you power off.

For Setting	With the power already on - - -
Increase mic gain (15 steps)	Press <b>IC2</b> while you repeatedly press the ▲ volume up button
Decrease mic gain (15 steps)	Press <b>IC2</b> while you repeatedly press the ▼ volume down button
<b>BP210 only *</b> Increase sidetone level (5 steps)	Press <b>IC1</b> while you repeatedly press the ▲ volume up button
<b>BP210 only *</b> Decrease sidetone level (5 steps)	Press <b>IC1</b> while you repeatedly press the ▼ volume down button

\* **NOTE:** There is no sidetone adjustment function for All-In-One Headsets.



**NOTE:** If you are not connecting a wired intercom, go on to [System Operation, section 3, page 14.](#)

## 2.4 Interfacing with 2-Wire or 4-Wire Intercoms

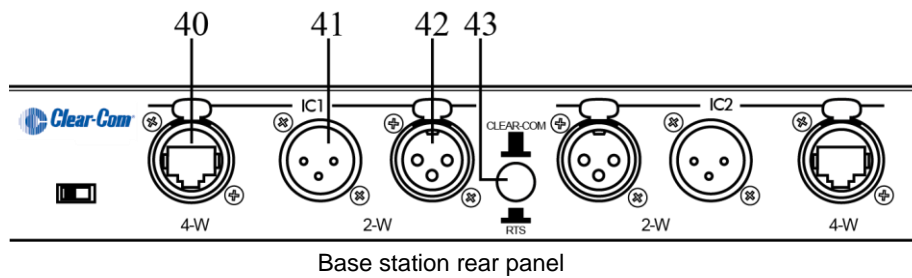

### 2-Wire Intercom Interface:

The following 2-wire setup is for Channel 1 (IC1). **If applicable, repeat for Channel 2 (IC2).**

- **If using a 2-wire intercom** with the DX210, plug the appropriate male or female connector into the base station **2-W** connector at #41 or #42
- Depending on whether you are using a Clear-Com® or RTS® compatible 2-wire intercom system, position the **CLEAR-COM / RTS** button (#43) as follows:  
In position = RTS Mode Out position = Clear-Com Mode
- Press the **IC1 SELECT** button (#12) on the front panel of the base station. The **2-W** light (#10) next to the button should turn green.

**NOTE:** If no power is detected at the **2-W** connector, the **2-W** light will turn red and no audio will be passed through. Plugging in a connection to a Clear-Com or RTS power supply will turn the light green and operation will begin.

- Be sure there are no open microphones on the wired intercom. **If users are wearing headsets, please notify them of the impending audio sweep prior to auto nulling.** Press and hold the **AUTO NULL** button for two seconds. To press the **AUTO NULL** button, insert a pen or similar pointed object into the **AUTO NULL** hole on the front panel of the base station. An audio sweep will be heard for 25 seconds on the wired Beltpacks. (The **2-W** light (#10) next to the button should turn amber, then green.)
- Adjust the 2-W intercom receive and send levels with the **IC1 2-W INPUT** control (#9) and **OUTPUT** control (#8).

**NOTE:** If you are not connecting other equipment, go on to [System Operation, section 3, page 14](#).

### 4-Wire Intercom Interface:

The following 4-wire setup is for Channel 1 (IC1). **Repeat for Channel 2 (IC2) if applicable.**

- **If using a 4-wire intercom** with the DX210, plug it into the base station **IC1 4-W** connector (#40).
- Press the respective **SELECT** button until the **IC1 4-W** light (#13) next to the button turns on.
- Adjust the 4-wire intercom receive and send levels with the **IC1 4-W INPUT** and **OUTPUT** (#14 & 15) controls.

RJ45 Connector Pins	Designation
Pins 1, 2, 7 and 8	N/C (reserved)
Pin 3	Intercom Out +
Pin 4	Intercom In +
Pin 5	Intercom In -
Pin 6	Intercom Out -

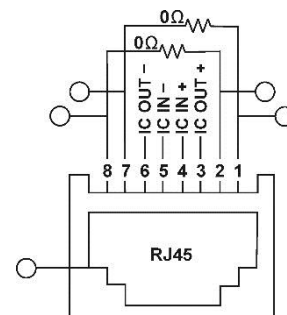

**NOTE:** Simultaneous 2-wire and 4-wire communication is possible.

Both groups of intercom users can communicate with the base station operator, but not with each other.

## IC1 and IC2 Intercom Controls and Indicator Lights:

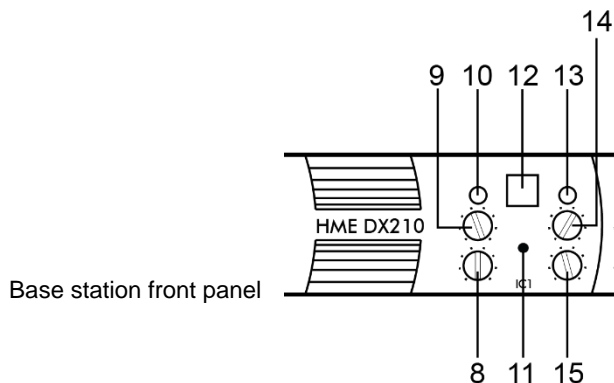

The **IC1** portion of this area of the panel is for Intercom Channel 1, and the **IC2** portion is for Intercom Channel 2. Their operation is identical.

- The **SELECT** button is used to select 2-Wire or 4-Wire or both.
- The **2-W indicator light** will come on **red** (muted) if wired intercom power is not detected at the 2-W connector on the rear panel of the base station. The **2-W indicator light** will come on **green** if 2-W equipment which supplies power is plugged into the 2-W connector on the rear panel of the base station, or if the respective bypass jumper inside the unit has been set.
- The **INPUT** controls are used to adjust the audio levels going to beltpack, all-in-one headset or a local headset coming in from 2-W and 4-W equipment connected to the base station.
- The **OUTPUT** controls are used to adjust the audio levels coming in from beltpacks and all-in-one headsets or a local headset, as it goes out to 2-W and 4-W equipment connected to the base station.
- The **AUTO NULL** button is used to eliminate echo caused by mismatched line characteristics of an external 2-W system. **CAUTION: Before pressing the AUTO NULL button, be sure there are no open microphones on the wired system.** Use a pen or similar pointed object to press and hold the **AUTO NULL** button for 2 seconds.

**NOTE:** If you are not connecting other equipment, go on to [System Operation, section 3, page 14.](#)

## 2.5 Interfacing with Auxiliary Audio Equipment

ISO Audio can be routed to the **AUX OUT** connector for page or stage announce.

- If using auxiliary audio equipment such as another intercom, a CD player, etc., connect its output cable connector (male) to the **AUX IN** connector (#48), and/or its input cable connector (female) to the **AUX OUT** connector (#49).

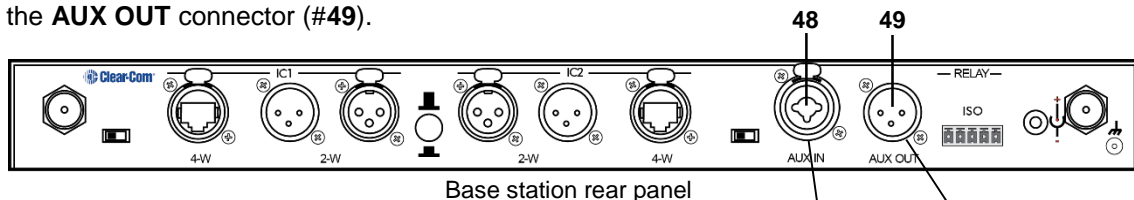

The cable connectors must be 3-pin XLR type for balanced +20dBu maximum audio input/output, with the following pin connections:

Pin 1 = Ground  
Pin 2 = Audio +  
Pin 3 = Audio -

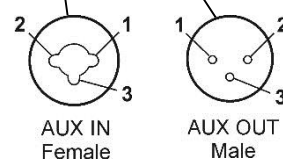

The **AUXILIARY SELECT** button (#25) is used to select **IC1** or **IC2** or both as the destination for **AUX IN** audio. The **IC1** and/or **IC2 INPUT ASSIGN** lights (#24) come on green to indicate the selection as the destination for **AUX IN** audio. If neither is selected, **AUX IN** audio will not be routed to the beltpack or all-in-one headset. The **AUX IN** light must be lit for the **INPUT ASSIGN SELECT** function to operate.

- If only **AUX IN** is used, press the **AUX IN/OUT SELECT** button (#28) until the **IN** light (#27). Listen to the headset audio input as you adjust the **INPUT** control (#26) below the light to the desired level.
- If only **AUX OUT** is used, press the **AUX IN/OUT SELECT** button (#28) until the **OUT** light (#29) comes on. Check the audio level on the auxiliary equipment, and adjust the **OUTPUT** control (#30) to the desired level.
- If the auxiliary equipment requires two-way communication, have someone listening at the auxiliary unit. Press the **AUX IN/OUT SELECT** button (#28) until both the **IN** and **OUT** lights (#s 27 and 29) go on. While speaking into your headset microphone, adjust the **OUT** control (#30) above the light to the desired listening level at the auxiliary unit. Listen to the audio input in your headset as you adjust the **INPUT** control (#26) below the light to the desired level.

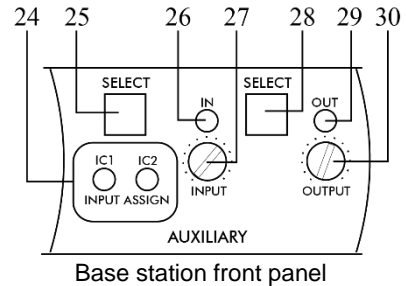

### Auxiliary Controls and Indicator Lights:

- The **SELECT** button on the right (#28) is used to select **AUX IN** (audio from auxiliary equipment connected to the base station), **AUX OUT** (audio to the auxiliary equipment from the ISO channel of the beltpack, all-in-one headset or local headset).
- The **IN** and **OUT** lights come on green to indicate the selection.
- The **INPUT** and **OUTPUT** controls adjust auxiliary inbound and outbound audio levels.
- The **SELECT** button on the left (#25) is used to select **IC1** or **IC2** or both as the destination for **AUX IN** audio. The **IC1** and/or **IC2 INPUT ASSIGN** lights come on green to indicate the selection as the destination for **AUX IN** audio.

**NOTE:** If you are not connecting other equipment, go on to [System Operation, section 3, page 14.](#)

## 2.6 ISO Relay

During ISO communication, a relay closure is provided. This can be used for tasks such as keying a long range radio or triggering an alert light. It can be activated from a beltpack, all-in-one headset or a local headset.

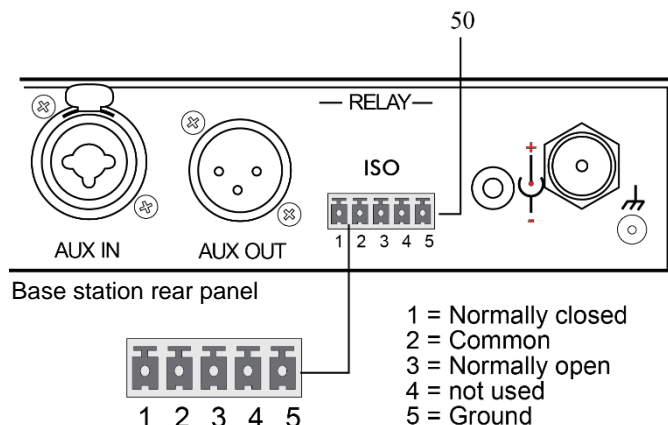



# 3 System Operation

This chapter describes how to operate the Base Station, Backpack or All-In-One Headset.

## 3.1 Base Station Operation

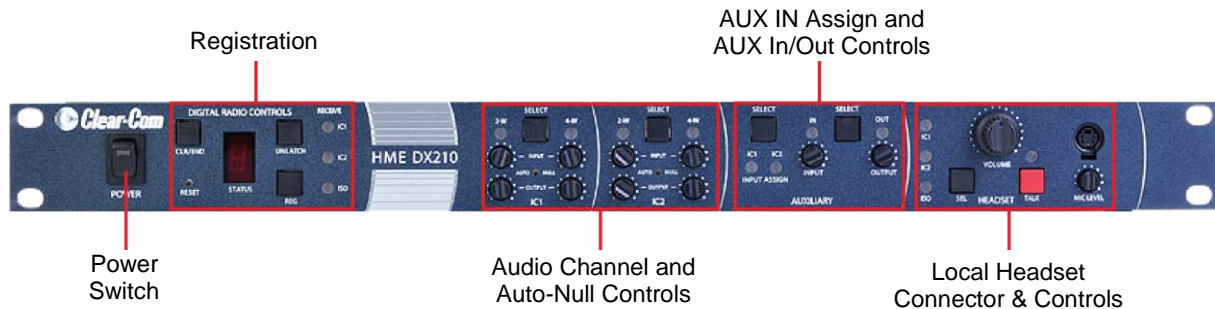

### 3.1.1 Digital Radio Controls and Indicator Lights

- The **CLR/BND** button, **RESET** button, **STATUS** indicator and **REG** button are used when registering backpacks and all-in-one headsets. Refer to [Registration procedure, page 9](#).
- The **UNLATCH** button is used by the base station operator to unlatch **all** backpacks and all-in-one headset transmitters.
- The **RECEIVE IC1**, **IC2** (Intercoms) and **ISO** (Isolate) lights indicate whether reception from a Backpack or all-in-one headset is on **IC1**, **IC2** or **ISO**.



### 3.1.2 Local Headset Connector, Controls and Indicator Lights

- The **SEL** (select) button is used to select communication from the local headset to **IC1**, **IC2**, **IC1 & IC2** or **ISO**.
- The **IC1**, **IC2**, **IC1 & IC2** or **ISO** indicator light will be lit for the selection you made.
- **IC1** and **IC2** communication will be heard by wireless users on the respective channel, as well as users wired into 2-W and 4-W connections.
- **ISO** is heard in both wireless channels, and **AUX OUT** if activated.  
**NOTE:** When the **ISO** button is pressed, **ISO RELAY** (#50) is activated.
- The **TALK** button is used for communication from the local headset to the selected channel.  
**For open communication**, press and release the **TALK** button quickly to “latch on”. To “latch off,” press and release the button again quickly.  
**For momentary communication**, press and hold the **TALK** button for more than one second. In this mode, the selected channel will remain open only as long as you are pressing the **TALK** button. The **TALK** light indicates that the **TALK** mode is active via the local headset.
- Use the **VOLUME** control to adjust the output to the local headset earpiece.
- Use the **MIC LEVEL** control to adjust the audio level from the local headset microphone.





## 3.2 Beltpack and All-in-One Headset Operation

Beltpack control buttons have a snap action. They will activate when pressed firmly. Use your fingertips to press the Beltpack buttons. All-In-One Headset buttons are touch sensitive.



### 3.2.1 Power On/Off

- **Power On** – Press and release the **PWR** (power) button. A headset voice message will say “power on,” and the red power lights near the corners of the **IC1** and **IC2** buttons will go on. After a short time, one light will turn off and the other will change to green, indicating the Beltpack is ready for use. The **STATUS** indicator on the base station will momentarily indicate the ID of the Beltpack.

The green power light will be on steady whenever the Beltpack is ready, but not transmitting.

**NOTE:** While the Beltpack is transmitting, the green power light will be flashing.

- **Power Off** – Press and hold the **PWR** button for approximately two seconds. A headset voice message will say “power off,” and the green power light will turn off.

### 3.2.2 ISO (Isolate) and IC1, IC2 (Intercom)

Use the **ISO** button to talk to other wireless beltpack or all-in-one headset users and the base station operator. Pressing **ISO** on the Beltpack will also send audio to **AUX OUT** if the **AUXILIARY OUT** light on the front of the base station is on. Use the **IC1** and **IC2** buttons to communicate via the wired intercom channels and the base station operator. When the **ISO** button is pressed, **ISO RELAY (#50)** is activated.

### 3.2.3 Operating Modes

- **Push-To-Talk ONLY Mode Operation** – In PTT operation, audio is transmitted only while you are pressing and holding the **IC1**, **IC2** or **ISO** button. When you release the button, transmission stops.
- **Hands-free Mode Operation** – Quickly press and release the **IC1**, **IC2** or **ISO** button to “latch” the transmitter on. Talk and listen, as in a normal telephone conversation. Quickly press and release **the same button** again to “unlatch,” and end the conversation. The base station operator can unlatch all beltpacks and all-in-one headsets by pressing the **UNLATCH** button on the base station.

**NOTE:** In the hands-free mode, if you are latched in **IC1**, **IC2** or **ISO**, quickly pressing/releasing either of the other buttons will latch on that button.

If you are latched in **IC1** or **IC2** (in hands-free mode) and then press and hold the **ISO** button, it will function as PTT. When you release the **ISO** button, the beltpack or all-in-one headset will revert to the latched **IC1** or **IC2**.

Refer to [Indicator light functions, Appendix A, page 21](#).

### 3.2.4 Volume Up/Down

- **Volume Up Adjustment** – Each time you press and release the volume-up ▲ button, a beep will be heard in the earpiece as the volume increases one step. If you press and hold the volume-up button, repeating beeps will be heard as the volume steps up to maximum. When maximum volume is reached, “maximum” will be heard in the earpiece, and will be repeated until you release the volume-up button.
- **Volume Down Adjustment** – Each time you press and release the volume-down ▼ button, a beep will be heard in the earpiece as the volume decreases one step. If you press and hold the volume-down button, repeating beeps will be heard as the volume steps down to minimum. When minimum volume is reached, rapidly repeating beeps will be heard.

### 3.2.5 Adjusting Microphone Gain

Some users talk louder/softer than others. To allow for this, microphone gain adjustment is provided.

- **To increase microphone gain** – While holding down the **IC2** button, press the volume-up ▲ button as many times as necessary to reach the desired level. The microphone gain increase can be monitored through side tone, or preferably by someone else using a beltpack or all-in-one headset or at the base station.
- **To decrease microphone gain** – While holding down the **IC2** button, press the volume-down ▼ button as many times as necessary to reach the desired level. The microphone gain decrease can be monitored through side tone, or preferably by someone else using a beltpack or headset or at the base station.

**NOTE:** The mic gain setting will be indicated by a voice prompt (typically, HS14 = 5, HS15 = 3, HS16 = 3). You will hear “Maximum” if you attempt to go higher than maximum mic gain. You will hear repeating beeps if you attempt to go lower than minimum mic gain. Microphone gain will be saved in memory and does not require readjustment each time the power is turned on. (Default setting is 3.)

### 3.2.6 Adjusting BP210 Beltpack Side Tone

- **To increase side tone** – Press the volume-up ▲ button while holding down the **IC1** button in the normal operating mode.
- **To decrease side tone** – Press the volume-down ▼ button while holding down the **IC1** button in the normal operating mode.

**NOTE:** The side tone setting will be indicated in numbers, by a voice prompt. (Default setting is “Max”.)

### 3.2.7 Using WH220 All-In-One Headset Lights-Off Mode

The Lights-Off mode can be used to avoid audience distraction from the lights on the All-In-One Headsets.

- **To operate in the Lights-Off mode** (with the WH220 power off), press and hold the **IC2** button while you press the **POWER** button and then release both buttons.
- **To get out of the Lights-Off mode**, power the WH220 off and back on again without pressing the **IC2** button.

**NOTE:** There is no sidetone adjustment number for the All-In-One Headset.

### 3.2.8 Changing Batteries

When a battery becomes weak, a voice in the earpiece will say “Change battery”. If using a Beltpack, you must remove it from its pouch to access its battery.



**Beltpack battery removal**



**All-In-One Headset battery removal**

For the **Beltpack**, slide the arrow-shaped battery release latch in the direction of the arrow. Pull up on the battery near the battery-release latch and lift the battery out of the unit, or turn the unit over and catch the battery in your hand. Replace the battery in the same position as the removed battery, and snap it into place.

For the **All-in-One headset**, press the blue Battery-release button, and slide the battery out from under the earpiece. Replace the batter in the same position as the removed battery, and snap it into place.

# 4 Troubleshooting

- **Red light on base station power switch does not come on.**

Be sure the power cords are properly connected to base station, power supply and electrical outlet.

- **Beltpack power lights do not turn green and “out of range” is heard in the headset.**

Be sure your base station power is on. Turn the Beltpack and base station power on and off. You may be too far from the base station. The range varies with each location’s layout.

- **When trying to register, it keeps saying registration failed.**

Refer to [“If registration failed” in section 2.3.2, page 9](#), and repeat the registration procedure. If “F” appears in the STATUS display, it indicates that an attempt has been made to register more than 15 Beltpacks. Follow the [related instructions in section 2.3.2, page 10](#).

- **Others cannot hear me when I talk.**

Be sure the headset is securely connected to the Beltpack or base station, and that you are pressing the **IC1, IC2** or **ISO** button on the Beltpack or the **TALK** button on the base station. Be sure the appropriate **IC1, IC2** or **ISO** setting is selected in the **HEADSET** section of the base station front panel.

- **People on the 4-wire intercom cannot hear me or I cannot hear them.**

Be sure the cables are securely connected and the 4-wire intercom is on. If using a local headset, be sure the desired **IC** setting is selected in the **HEADSET** section of the base station front panel. If using a Beltpack or All-In-One Headset, press the desired **IC** button.

- **People on the RTS®/Clear-Com® systems cannot hear me, or I cannot hear them.**

Be sure the cables are securely connected and the 2-wire intercom is on. If using the local headset, be sure the desired **IC** setting is selected in the **HEADSET** section of the base station front panel. If using a Beltpack or All-In-One Headset, press the desired **IC** button.

- **The 2-wire intercom is on and there is a loud squeal whenever I try to talk.**

This can occur if two or more base stations are daisy-chained without terminating the appropriate channel. The termination is set by putting JP5 (IC1) and/or JP6 (IC2) in the **ON** position. This should be done in only one base station. Refer to [Appendix C, page 23](#) for jumper (JP) locations.

- **Settings are not retained when the base station power is turned off and on again.**

The internal battery may be low. Contact your dealer.

- **2-W LEDs remain red. No 2-wire power detected.**

Plug into 2-W power supply. If the lack of powered 2-W system is intentional (such as when using a Clear-Com MT1, or when daisy-chaining multiple base stations), open the base station cover and set JP1 (IC1) and/or JP2 (IC2) to the **ON** position. If daisy-chaining, do not forget to also terminate one of the base stations by setting JP5 (IC1) and/or JP6 (IC2) to **ON**. Refer to [Appendix C, page 23](#) for jumper (JP) locations.

- **Echo on 2-W line.**

Be sure no wired Beltpacks have open mics and that the line is terminated, and rerun Auto Null.

# 5 Technical Data

## 5.1 BS210 Base Station Specifications

GENERAL	
Channels:	2 audio channels
Frequency Range:	2400 – 2483.5 MHz
Frequency Response:	200 Hz to 3.5 kHz
Power Requirements:	100-240VAC, 50-60Hz or 12-14VDC
Temperature Range:	32-122°F (0-50°C)
Size:	19" x 1.72" x 17.13" (1-RU) (48.26 x 4.37 x 43.51 cm)
Weight:	9.0 lbs. (4.1 kg) maximum
# of registrations per Base:	15 can be registered.  In single-channel operation, 4 can have simultaneous full-duplex communication. In dual-channel operation, 3 can have simultaneous full-duplex communication.
4-Wire I/O:	RJ45, 600Ω balanced, level adjustable, simultaneous operation with 2-wire
2-Wire I/O:	XLR-3M, XLR-3F, externally-switchable RTS® or Clear-Com® mode, 200Ω, level adjustable, null adjustable to 50dB attenuation, typical
Auxiliary Input:	XLR-3F/¼" (6.35 mm) combo jack, 600Ω balanced, level adjustable
Auxiliary Output:	XLR-3M, 600Ω balanced, level adjustable
Headset Connector:	4-pin mini-DIN, Electret microphone
Headset Output:	200mW into 32Ω
Antenna Type:	External ½ -wave dipole (R-TNC connector), RX/TX horizontal/vertical diversity
System Distortion:	<2%
Communication Security:	64-bit encryption, dual-slot diversity
BASE STATION TRANSMITTER	
Type:	Frequency Hopping, Spread Spectrum (FHSS)
Transmit Power:	100mW burst
Modulation Type:	Gaussian filtered FSK, TDMA
Frequency Stability:	13 ppm
Harmonics/Spurious:	Exceeds FCC and ETSI specifications over temperature
BASE STATION RECEIVER	
Type: RF Sensitivity:	Frequency Hopping, Spread Spectrum <-90dBm w 10-3 BER
Frequency Stability:	13 ppm
Distortion:	<2%

## 5.2 BP210 Beltpack Specifications

### GENERAL

<b>Channels:</b>	2 audio channels
<b>Frequency Range:</b>	2400 MHz – 2483.5 MHz
<b>Antenna:</b>	Internal, horizontal/vertical diversity
<b>Frequency Response:</b>	200 Hz to 3.5 kHz
<b>Battery Requirements:</b>	3.6V lithium ion
<b>Battery Life:</b>	Up to 20 hours
<b>Temperature Range:</b>	32-122°F (0-50°C)
<b>Weight:</b>	7.4 oz (.21 kg) with battery and pouch
<b>Headset Connector:</b>	4-pin, mini-DIN
<b>Microphone:</b>	Electret
<b>Headset Output:</b>	160mW into 32Ω
<b>Controls:</b>	Power, Volume-up, Volume-down, IC1, IC2, ISO
<b>Indicators:</b>	Dual-color LED (red/green)
<b>Communication Security:</b>	64-bit encryption
<b>System Distortion:</b>	<2%

### BELTPACK TRANSMITTER

<b>Type:</b>	Frequency Hopping, Spread Spectrum
<b>Transmit Power:</b>	100mW burst
<b>Transmission Modes:</b>	Momentary or latch
<b>Modulation Type:</b>	Gaussian filtered FSK, TDMA
<b>Frequency Stability:</b>	13 ppm
<b>Harmonics/Spurious:</b>	Exceeds FCC and ETSI specifications

### BELTPACK RECEIVER

<b>Type: RF Sensitivity:</b>	Frequency Hopping, Spread Spectrum <-90dBm w 10-3 BER
<b>Frequency Stability:</b>	13 ppm
<b>Distortion:</b>	<2%

## 5.3 WH220 All-In-One Headset Specifications

GENERAL	
Channels:	2 audio channels
Frequency Range:	2400 MHz – 2483.5 MHz
Antenna:	Internal
Frequency Response:	200 Hz to 3.5 kHz
Battery Requirements:	3.6V lithium ion
Battery Life:	Up to 20 hours
Temperature Range:	32-122°F (0-50°C)
Weight:	5.7 oz (.16 kg) with battery
Microphone:	Electret
Headset Output:	160mW into 32Ω
Controls:	Power, Volume-up, Volume-down, IC1, IC2, ISO
Indicators:	Dual-color LED (red/green)
Communication Security:	64-bit encryption
System Distortion:	<2%
HEADSET TRANSMITTER	
Type:	Frequency Hopping, Spread Spectrum
Transmit Power:	100mW burst
Transmission Modes:	Momentary or latch
Modulation Type:	Gaussian filtered FSK, TDMA
Frequency Stability:	13 ppm
Harmonics/Spurious:	Exceeds FCC and ETSI specifications
HEADSET RECEIVER	
Type: RF Sensitivity:	Frequency Hopping, Spread Spectrum <-90dBm w 10-3 BER
Frequency Stability:	13 ppm
Distortion:	<2%



## Appendix A: Indicator Light Functions

### BP210 Backpack Indicator Lights:

BP210 Condition	IC1 Indicator Light	IC2 Indicator Light
IC1 Idle	Steady Green	OFF
IC1 TX	Blinks Green	OFF
IC2 Idle	OFF	Steady Green
IC2 TX	OFF	Blinks Green
ISO TX	Blinks Green	Blinks Green
Low battery	Appropriate channel light Blinks Red when in idle mode	

### WH220 All-In-One Headset Indicator Lights:

WH220 Condition	Main Indicator Light	Boom Indicator Light
IC1 Idle	Steady Green	Off
IC1 TX	Blinks Green	Steady Green
IC2 Idle	Steady Red	Off
IC2 TX	Blinks Red	Steady Green
ISO TX	Blinks Red or Green (depending on previous Mode)	Steady Red
Low battery	No indication	

# Appendix B: Multiple Base Station Daisy-Chaining

Two or more DX210 base stations can be “daisy-chained” using the 2-W connector ports on the rear panels of each base station (following Clear-Com® / RTS® standards), or two base stations (not more) can be “daisy-chained” together with cables connected to the 4-W or AUX connectors.

**NOTE 1:** DX210 does not provide 2-wire line power, therefore, 2-wire power bypass must be used.

RTS® Mode	Clear-Com® Mode
Pin 1 = Common	Pin 1 = Common
Pin 2 = Channel 1	Pin 2 = N/C
Pin 3 = Channel 2	Pin 3 = Audio

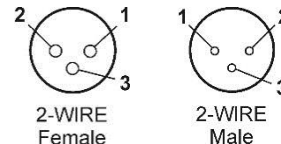

**NOTE 2:** For AUX type daisy-chaining, the cable connectors must be 3-pin XLR.

- If using 4-wire connection, use cable with In/Out crossed, as shown to the right.  
(An Ethernet crossover cable will not work.)
- If using 2-Wire connections, open each base station and set jumpers JP1 (IC1) and/or JP2 (IC2) **in all base stations** to ON for power detect bypass. Set jumpers JP5 (IC1) and/or JP6 (IC2) **in only one base station per channel** for termination. Refer to [Appendix C, page 23](#).
- Perform base station registration for each base station. Refer to [Appendix D, page 24](#).

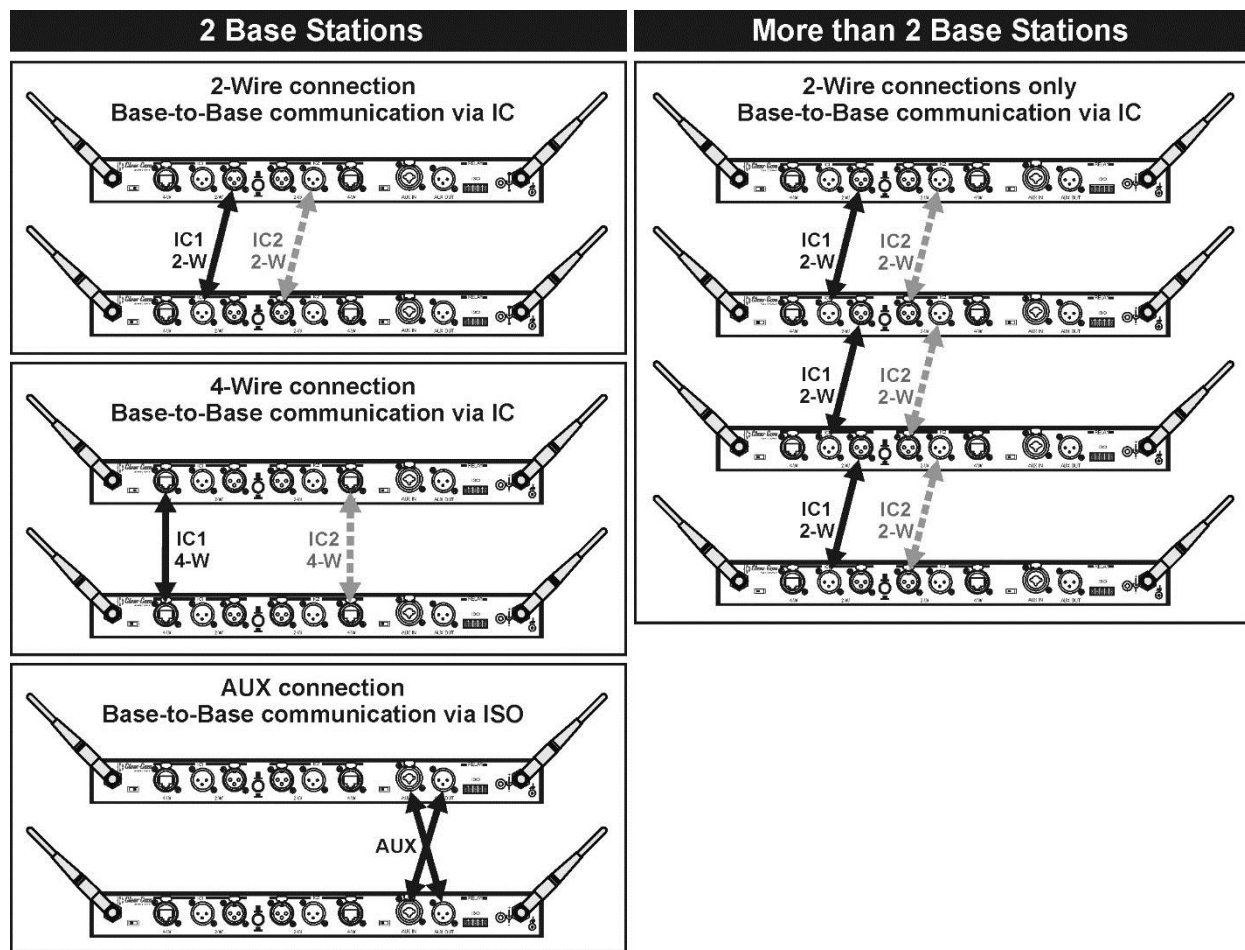
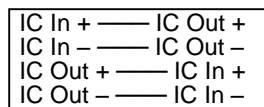

## Appendix C: Jumper Settings

The base station has internal jumpers that are used to set ISO broadcast restrict, power detect by-pass and 2-wire channel termination.

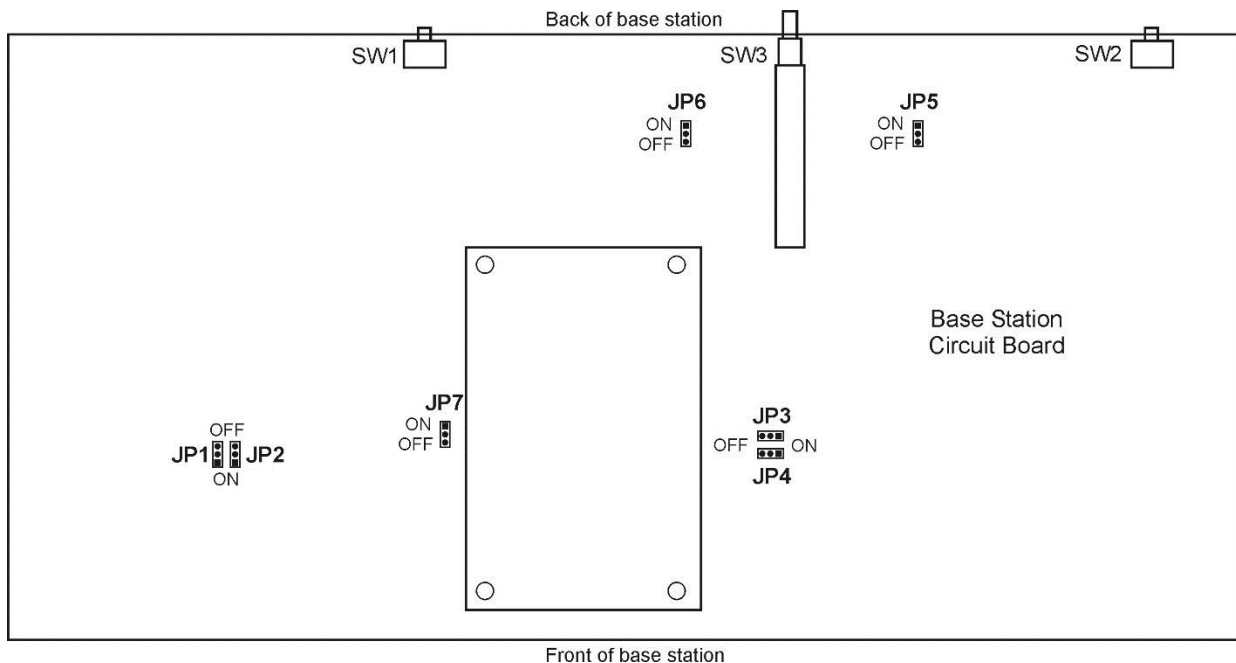

Jumper #	Function
JP1	Channel 1, 2-wire power detect bypass
JP2	Channel 2, 2-wire power detect bypass
JP3	Reserved
JP4	Disable ISO from going out to Beltpacks
JP5	Channel 1, 2-wire termination
JP6	Channel 2, 2-wire termination
JP7	Reserved

### ISO Broadcast Restrict

This feature prevents ISO communication from being broadcast from one beltpack or all-in-one headset to another. Local headset ISO will still be broadcast, and the local headset will still receive ISO communication. To enable this feature, set JP4 to ON.

### Power Detect Bypass

In the event the DX210 base station is connected to a 2-W line which does not contain power (such as when multiple base stations are daisy chained), JP1 (IC1) and/or JP2 (IC2) need to be set to ON to enable 2-W interface for the respective channel(s) to come on.

**WARNING! If no termination is present on the line, enabling this feature will cause feedback in the headsets.**

### 2-Wire Channel Termination

If termination of the base station is necessary (such as when multiple base stations are daisy chained), set the JP5 (IC1) and/or JP6 (IC2) jumpers to the ON position on one base station (when connecting multiple base station together via 2-wire connection). Only one base station should be terminated per channel.

## Appendix D: Multiple Base Station Registration

For multiple base stations to operate in close proximity without interference, they must be properly registered before performing other setups. After registering each base station, register each beltpack or all-in-one headset that will be used with that base according instructions in [section 2.3.2, page 9](#).

**NOTE:** If using split-band operation, select the appropriate band prior to base station registration. If a different frequency band needs to be selected to avoid interference, the primary base station must be set to this frequency band before base station registration is started.

### Register each base station and all Beltpacks and/or All-In-One Headsets as follows:

- On one of the base stations, ensure that the primary/secondary switch is set to primary. On the others, ensure that it is set to secondary. **NOTE:** In split band operation, there can be one primary and up to three secondary base stations in either band.
- Turn the primary base station power on. Register any beltpack or all-in-one headset to be used with the primary base station, as instructed in [section 2.3.2, page 9](#). Turn each beltpack or all-in-one headset off after registering it.
- Power on one **secondary** base station. The **STATUS** display will show a double bar, indicating the secondary base station is ready to be registered.

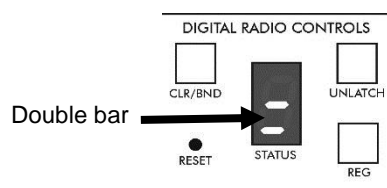

**Base station ready to be initialized**

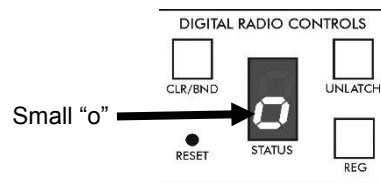

**Small "o" indicates primary base station is open for registration**

- Press the **REG** (register) button on the primary base station. The **STATUS** display will show a small "o".
- To assign a number to a secondary base station and register it, press the **REG** button on the secondary base station. Pressing the button repeatedly cycles through the numbers 1, 2, and 3. When the desired number appears, stop pressing and wait. While the secondary base station is registered using the displayed number, the **STATUS** display will continue showing the secondary number selected. When registration of the secondary base station is finished, the display will show one bar to indicate the secondary has been registered to the primary.

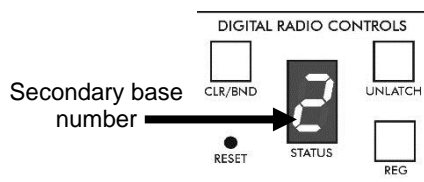

**Secondary 2 searching for primary**

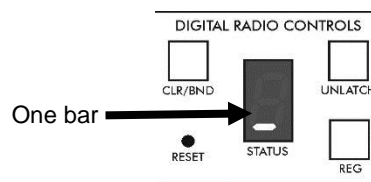

**Secondary is initialized to primary**

- Press the **REG** button on the primary. The **STATUS** display will go blank.
- Register beltpacks and all-in-one headsets to the secondary base stations as instructed in [section 2.3.2, page 9](#). After registration, turn off the secondary base station and all beltpacks and all-in-one headsets.

- Repeat these steps for each remaining secondary base station. Use a different number for each. Only the primary base station and the active secondary base station should have power on during registration. All other equipment should be off.
- After all secondary base stations, beltacks and all-in-one headsets are registered, power up all base stations. Press reset on the primary base station and let it recover. Turn on the primary beltacks and all-in-one headsets, and let them link.
- Press the reset on each secondary base station one at a time and let it link to the primary, as indicated by a single bar. Turn on the beltacks and all-in-one headsets associated with the secondary base stations. Work on one group at a time until they have all linked, and then do the next group. At this point all base stations, beltacks and all-in-one headsets should be powered up and linked, ready for use.
- Now proceed with normal system configuration, setting functions and levels as required.
- If it becomes necessary to replace a secondary base station, use the procedure above to register the new secondary with the same number as the old secondary. After registration, you will have to register any beltacks and all-in-one headsets associated with the old secondary to the new secondary base station.
- If it becomes necessary to replace a primary base station, follow the above procedure completely. Before registration of the secondary base stations, clear the previous secondary registration as follows:
  - For each secondary, press the **CLR/BND** button and the **RESET** button simultaneously. Continue holding the **CLR/BND** button after you release the **RESET** button, until the clear code “c” (lower case) appears on the **STATUS** display. Any beltacks and all-in-one headsets associated with the old primary will have to be registered to the new primary after secondary base station registration. All beltacks and all-in-one headsets associated with secondary base stations also have to be registered again.
- If the primary base station is shut down or if the primary base is powered off for more than 30 seconds, all secondary base stations will drop their beltack and all-in-one headset connections and begin searching for the primary. If the primary is not found in 30 seconds, the secondary will automatically revert to primary-mode operation and reconnect the beltacks and all-in-one headsets. At this point the secondary **STATUS** displays will show three bars. If the primary is turned back on it will be necessary to press **RESET** on all secondary base stations to allow them to find and initialize to the primary again. It is therefore important to have all base stations connected to the same AC circuit to prevent this situation when the system is shut down after hours and powered up again the next day.

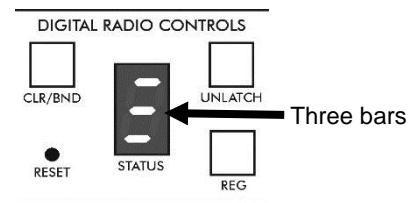

**Secondary base station operating in primary mode when no primary base station is found**

**NOTE:** You cannot register beltacks and all-in-one headsets to a base that is set to primary mode, and then switch the base mode to secondary for registration. Once in secondary mode, the base station cannot recognize the beltacks and all-in-one headsets registered during primary operation. For secondary base stations, the beltacks and all-in-one headsets must always be registered after secondary base station registration, with the primary base station remaining active and the secondary base station displaying one bar.

## Appendix E: Interference Avoidance through Spectrum Friendly

Interference, heard in a headset as popping sounds, may occur whenever other equipment such as Wi-Fi systems or wireless DMX systems use the same frequency band. Some systems can be limited to one portion of the band. If so, the DX210 can be set to the opposite half of the 2.4 GHz to 2.48 GHz band. To avoid this type of interference, select the upper or lower part of the frequency range.

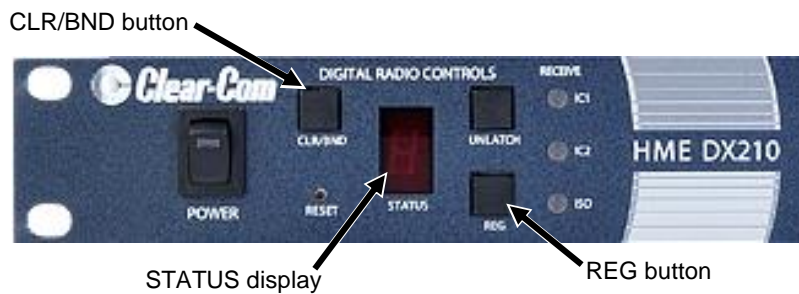

- Turn on the base station power. An “8” will appear on the **STATUS** display for a few seconds.
- After the “8” disappears from the **STATUS** display (primary base station) or displays a double bar (secondary base station), press and hold the **CLR/BND** button. Then, while you are still holding the **CLR/BND** button, press and hold the **REG** button and wait until a **L**, **H** or **A** appears and then release both buttons.

**NOTE:** Base stations are shipped in the **A** (default) position.

- Press the **CLR/BND** button to cycle through parts of the frequency band, (**L** = Low end, **H** = High end, and **A** = All) and stop on the desired setting.



- **Wait** until “c” appears on the display.



**NOTE:** “c” will only appear on the **STATUS** display if you are setting the frequency band the first time, or you are changing the setting. If you stop at **L**, **H** or **A** that was already set, an “8” will appear for a few seconds and the **STATUS** display will become blank.

- Register all beltacks and all-in-one headsets to be used with each base station as instructed in [section 2.3.2, page 9](#).

**NOTE:** If you change a base station’s frequency band setting, you will have to re-register all beltacks and all-in-one headsets that were registered to that base station.

## Spectrum Friendly

All DX Series wireless intercom systems now feature Spectrum Friendly™ technology for interference-free operation in the increasingly crowded 2.4GHz frequency band. This new technology enables broadcast and theatrical production crews to avoid emerging frequency conflicts by designating the 2.4GHz operating frequency range: low-, high-, or full-band.

While generally not a problem when separated, multiple applications and multiple users of the same applications in close proximity can result in additional risk for trouble-free operation. The new technology further ensures that products do not add interference to the spectrum for other essential wireless services in the vicinity, such as DMX-controlled lighting.

## Avoiding Wi-Fi Interference

To avoid interference with Wi-Fi systems, it is recommended to set the Wi-Fi system to something other than channel 6 or 7.

Your DX210 should be set to the high or low band opposite any Wi-Fi frequency range in use.

	DX210 Low Band = 2.4000-2.4400 GHz							DX210 High Band = 2.4433-2.4830 GHz						
Channel	1	2	3	4	5	6	7	8	9	10	11	12	13	14
Wi-Fi Frequencies	2.412	2.417	2.422	2.427	2.432	2.437	2.442	2.447	2.452	2.457	2.462	2.467	2.472	2.484



# Appendix F: Adaptive Frequency Hopping

## Background

The Clear-Com DX wireless intercom systems utilize a **Frequency Hopping Spread Spectrum (FHSS)** radio in order to provide robust communications.

This system operates in the unlicensed 2.4 GHz band. With the proliferation of other devices over the past few years in the same 2.4 GHz band, instances where these devices and systems can interfere with each other has greatly increased.

To further complicate matters, the European Union has introduced new radio standards for equipment operating in this band in an attempt to reduce interference between equipment from different manufacturers. This European Telecommunications Standards Institute (ETSI) harmonized European standard is known as EN 300 238 v1.8.1.

## CLEAR-COM Adaptive Frequency Hopping

In order to reduce interference with other equipment and comply with these new regulations, Clear-Com has implemented an **Adaptive Frequency Hopping (AFH)** mode for the new DX EU base stations. The key idea behind AFH is using only the good frequencies, or channels, unoccupied by other equipment. The system scans for other signals and avoids these signals during operation. Since the radio environment is constantly changing, there is a continuous process of scanning for used frequencies and updating the list of good channels.

The Clear-Com system utilizes 46 discrete frequencies, or channels, within the 2.4 GHz spectrum in order to communicate voice and data. The process of deciding which channels should be used is a 3-stage process. The process includes scanning for occupied channels, the broadcast of a channel exclusion list and the use of the exclusion list. The process is completed in three steps coexisting in time.

Below is the process is shown in Time. First, the system performs a channel scan to determine occupied channels. This list is then broadcast to the communicator. The communicators and base station will use this list during period three. The process is continuous, and as is illustrated below, the list could be constantly changing. Depending on the radio environment, a maximum of 46 channels, and a minimum of 15 channels may be used by the system at any time.

Time →

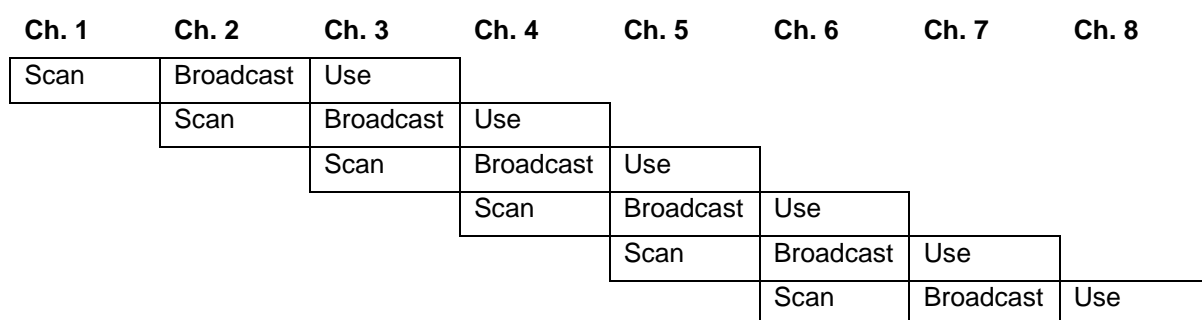

For instructions describing the process of setting the base to AFH or another scanning mode, see [Interference Avoidance through Spectrum Friendly](#), pg. 26. Available settings include:

**High (H)** - Scans the Higher frequencies.

**Low (L)** - Scans the Lower frequencies.

**All (A)** - All frequencies are scanned.

**AFH (E)** - (European Mode) Advanced Frequency Hopping searches for the best frequency.



## Operation in Severe Environments

During normal operation, the fact that the system is constantly changing the channel list in use is transparent to the user. It is possible, however, that in an environment with severe interference that the system may experience a slight degradation. In the AFH mode, the Clear-Com system will use a minimum of 15 channels. If the environment is very crowded and less than 15 channels are truly available, there could be increased radio 'packet loss' due to the high interference. The following symptoms may be observed with AFH systems in a highly congested radio environment:

- This may result in system 'busy' indications. Channel lists are updated every few seconds, and in a severe environment it is possible that these lists get missed by the communicator.
- Slight degradation in audio fidelity between the headsets and base station. This would be due to the same symptom as the 'busy' indications. The HD audio processing is tolerant to this condition, which is why the degradation may only be slight.
- Longer times to register. Registration may take longer, since the headset has to acquire the channel list from the base station. If the base station has excluded a lot of channels, this takes longer as the communicator does not have the exclusion list and looks for the base on channels it is not using.
- Initial sync time increase. For the same reason registration may take longer, the initial headset sync on power up may take longer.

## Required AFH Equipment

In order to utilize AFH, the base station must be set to European mode. The headsets and belt packs must also be AFH capable. AFH capable headsets and belt packs will have the letters 'AFH' labeled on the belt pack and headsets. AFH communicators will auto detect if the system is in AFH mode and adjust their operation accordingly.

## Non-AFH Equipment

Headsets and belt packs that are not AFH capable must be operated with either a non-AFH base station or an AFH base station selected to operate in All, High or Low band mode. Headsets and belt packs that are not AFH capable will not have the letters 'AFH'.

### AFH Model Chart

Model #	AFH Part #	Non AFH Part #	Comments
BP200	G29663-2B10	G26705-XXX	All BP200 Beltpacks with G26705-XXX part #'s are non AFH compatible.
BP210	G29663-2B10	G28703-XXX	All BP210 Beltpacks with G28703-XXX part #'s are non AFH compatible.
WH210		G28741-XXX	All WH210's are non AFH and will not work with Base in AFH mode.
WH200		G27593-XXX	All WH200's are non AFH and will not work with Base in AFH mode.
WH220	G29090-8D13		ALL WH220's are AFH compatible.
Part number is located on label under the battery on beltpacks and wireless headsets			

## Interference Mitigation

Certain techniques can be used in an attempt to mitigate interference between different equipment in the 2.4 GHz spectrum. Some of these are:

- **Physical separation.** If possible, equipment operating in the 2.4 GHz spectrum should be operating as far as physically possible from the HME base station. A Wi-Fi access point or router is a common piece of equipment that could interfere with the DX410 system, or vice versa. These two pieces of equipment in particular should not be located close together.
- **Spectral separation.** Most Wi-Fi access points allow the administrator to set the channel and bandwidth that system operates on. Some systems employ an 'auto' mode, in which the Wi-Fi access point will automatically selected the channel. With Wi-Fi access points, it is sometimes advantageous to manually select a channel number to keep the Wi-Fi transmission at a fixed location.

**NOTE:** If the Clear-Com system does not have AFH, then the base station should be set to operate in the region of the 2.4 GHz band where the Wi-Fi access point is not operating. For example, if the Wi-Fi access point is set to Wi-Fi channel 1, the base station should be set to operate in the 'High' band. If the Wi-Fi access point is set to channel 11, the base should be set to operate in the 'Low'.

- **Spectral efficiency.** Wi-Fi systems employ a standard sometimes referred to as 802.11. The number "11" is simply the number given to the standard by the Institute of Electrical and Electronics Engineers (the IEEE). Modern Wi-Fi routers will allow operation employing the 802.11n mode. This mode will allow higher data rates, but it also may consume twice the number of radio channels. If the Wi-Fi router is set to 802.11n mode, it is best to limit Wi-Fi bandwidth to 20 MHz.
- **Alternate band selection.** While most Wi-Fi systems operate at 2.4 GHz, which is the same band as the DX410 system. Most allow operation at 5 GHz. If possible, move any Wi-Fi access points and equipment to 5 GHz. This of course requires all Wi-Fi equipment to be 5 GHz capable, and most older equipment may only allow 2.4 GHz operation. Selection of 5 GHz may also not be desirable if the Wi-Fi network is for customer access.

## Non-Overlapping Channels for 2.4 GHz WLAN

### 802.11 channel width 22 MHz

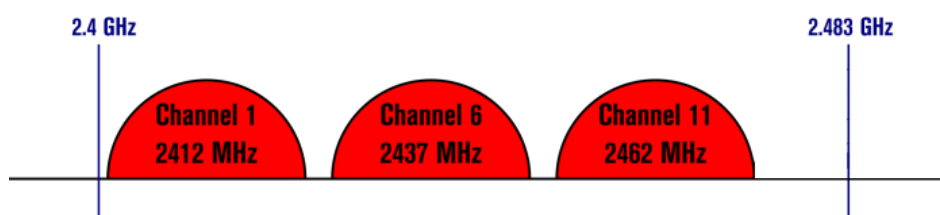

### 802.11 40 MHz ch. width

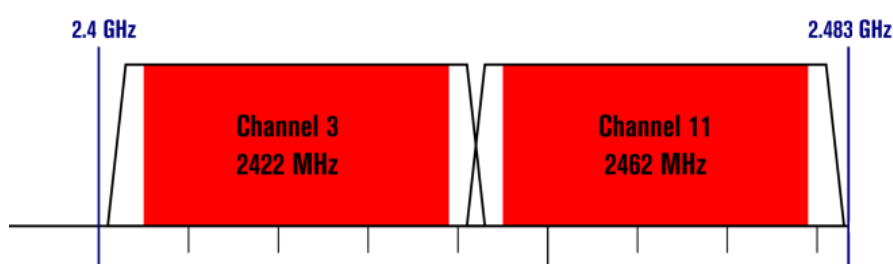

# Appendix G: Audio Routing Diagram

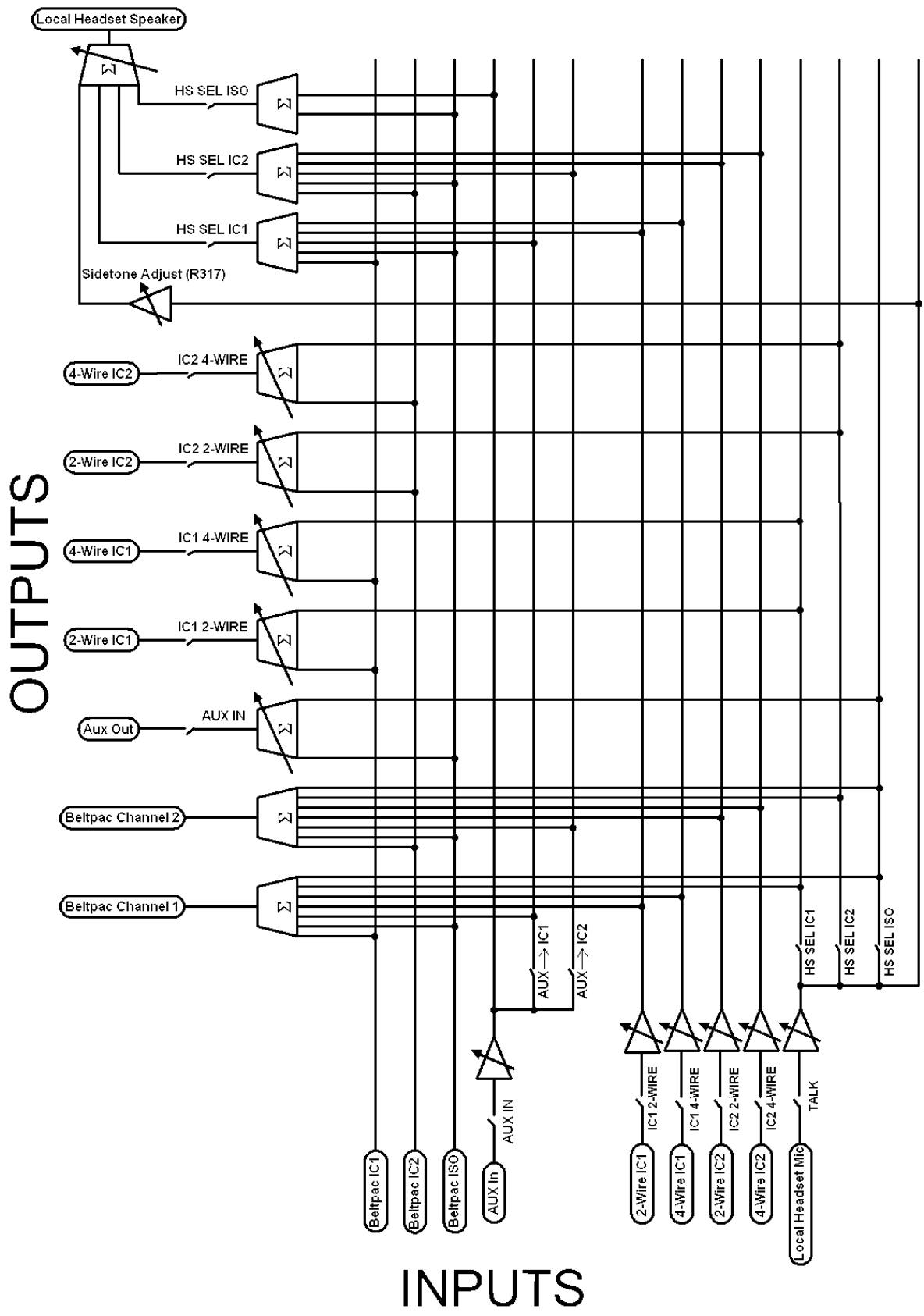

## Appendix H: Appendix G: DX Series LED Aid



Powering on any DX base station will produce on the LED display the number “8” for approximately 3 seconds.

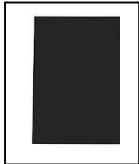

Blank display indicates the base is ready for operation.

**You can register Beltpacks under this condition.**



Single horizontal bar indicates the base is in secondary mode and registering to a base has been initiated and successfully linked with a primary base. **You can register beltpacks in this mode.**

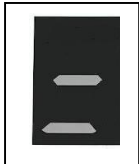

Two horizontal bars indicate that the base is in secondary mode and ready to be synced with a primary base. **You cannot register beltpacks in this mode you must sync to a primary base first.**

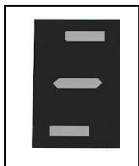

Three horizontal bars indicate the base is in secondary mode and has been linked with a primary base but the primary base is **no longer** available to the secondary. It takes a few seconds for the secondary to recognize that the primary is not available and revert to a primary state. **However, you can register Beltpacks under this condition.**

## Syncing Secondary to Primary Bases Feature

To sync the bases, perform the following steps: Press the **REG** or **REGISTER BELT-PAC\*** button on the primary base and then press the **REG** or **REGISTER BELT-PAC\*** button on the secondary base to begin the sync process. As you repeatedly press the **REG** or **REGISTER BELT-PAC\*** button on the secondary you will see the numbers 1, 2, and 3 cycle through on the display. The numbers indicate the three available quadrants. **Note: The primary is in the 0 quadrant by default.** To select a quadrant simply release the button at a desired number and wait. If successful, you will briefly see a blank display followed by a single horizontal bar in the secondary LED display. For additional secondary bases, assign each base to its own quadrant. Refer to the appropriate equipment manual for primary to secondary conversion.

After the bases are synced when the secondary is powered up the number “8” will appear followed by one of the numbers below on the secondary base LED display:

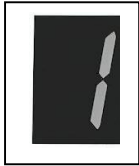

The number “1” indicates the quadrant the secondary has been placed in.



The number “2” indicates the quadrant the secondary has been placed in.



The number “3” indicates the quadrant the secondary has been placed in.



The lower case “c” will appear when the registry on the base station is cleared. To clear the registry power down the base. Hold down the **CLR/BND** or **RESET REGISTRATION\*** button first and then power the base on when you see the “8” on the LED display release the **CLR/BND** or **RESET REGISTRATION\***. If done successfully you will see a small "c" on the LED display. **NOTE: The display indicates that the registry of a base station has been cleared of all belt packs and secondary base stations that were registered to the base station.**

Another method to clear the registry would be to start by holding down the **CLR/BND** or **RESET REGISTRATION\*** button first and then pressing the **RESET** button until you hear a small click and then release the **CLR/BND** or **RESET REGISTRATION\*** button. If done successfully you will see a small "c" on the LED display. We recommend you use a very small paper clip.

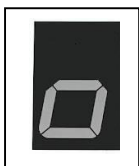

The lower case “o” will appear when the **REG** or **REGISTER BELT-PAC\*** button is pressed and indicates that the base is ready to register a belt pac.

When registering belt packs on DX bases that can carry 15 belt packs please note that the numeric count displayed on the LED will be in hexadecimal. This means that the LED will represent the first 10 belt packs as 0 to 9. Belt pac 11 will be represented by the letter A, belt pac 12 will be represented by the letter B and on up to belt pac 15 as E. Please see below.

Beltpac or Headset	1	2	3	4	5	6	7	8	9	10	11	12	13	14	15
Registry	0	1	2	3	4	5	6	7	8	9	A	B	C	D	E





The letter “F” will appear when the base registry is at its maximum of 15 registered Beltpacks. You will need to clear the registry to add a beltpac. To clear the registry power down the base. Hold down the **CLR/BND** or **RESET REGISTRATION\*** button first and then power the base on when you see the “8” on the LED display release the **CLR/BND** or **RESET REGISTRATION\***. If done successfully you will see a small "c" on the LED display.

## Spectrum Friendly Feature

**Spectrum Friendly option:** Hold down the **CLR/BND** (or **RESET REGISTRATION\***) button first then press and hold down the **REG** (or **REGISTER BELTPAC\***) button till you see the letter “A” or “L” or “H”. Then release both buttons and quickly press the **CLR/BND** (or **RESET REGISTRATION\***) to cycle through the “A” or “L” or “H”. options. Stop at your selection and wait for the LED display to go blank and a lower case c will appear on the status LED.

After this procedure is performed all bases, beltpacks and headsets will need to be re-registered to the base.



2400 to 2483.5 MHz is the operating frequency range.



2401.92 to 2439.94 MHz is the operating frequency range.



2443.39 to 2481.41 MHz is the operating frequency range.



有毒有害物质或元素表

Table of Toxic and Hazardous Substances

部件名称 Names of Parts	有毒有害物质或元素 Toxic and Hazardous Substances or Elements					
	铅 Pb	镉 Cd	汞 Hg	六价铬 Cr6+	多溴联苯 PBB	多溴二苯醚 PBDE
BS210 基站 Top assembly BS210 (G28707-1A1)	X	O	O	O	O	O
基站电路板 Audio PCB (G28718-1)	X	O	O	O	O	O
收发器电路板 Front Panel PCB (G28729-1)	X	O	O	O	O	O
收发器电路板 XCVR PCB (G27739-4A1)	X	O	O	O	O	O
AC40 电池充电器 AC40 (G27368)	X	O	O	O	O	O
电源器 (453G008) CCC P/S	X	O	O	O	O	O

**O:** 表示该有毒有害物质在该部件所有均质材料中的含量均在SJ/T11363-2006标准规定的限量要求以下。

**O: Indicates that this toxic or hazardous substance contained in all of the homogeneous materials for this part is below the limit requirements in SJ/T11363-2006**

**X:** 该有毒有害物质至少在该部件的某一均质材料中的含量超出SJ/T11363-2006标准规定的限量要求。

**X: Indicates that this toxic or hazardous substance contained in at least one of the homogeneous materials used for this part is above the limit requirements in SJ/T11363-2006**



有毒有害物质或元素表

Table of Toxic and Hazardous Substances

部件名称 Names of Parts	有毒有害物质或元素 Toxic and Hazardous Substances or Elements					
	铅 Pb	镉 Cd	汞 Hg	六价铬 Cr6+	多溴联苯 PBB	多溴二苯醚 PBDE
BP210 对讲机 Top Assembly BP210 (G27830-1A1)	X	O	O	O	O	O
对讲机电路板 XCVR PCB (G27560-1H1)	X	O	O	O	O	O
HS15 耳机 HS15/D Headset (306G100-1 /306G101-1)	X	O	O	O	O	O
对讲机套 Pouch (107G065)	O	O	O	O	O	O
电池 Battery (104034)	O	O	O	O	O	O

O: 表示该有毒有害物质在该部件所有均质材料中的含量均在SJ/T11363-2006标准规定的限量要求以下。

O: Indicates that this toxic or hazardous substance contained in all of the homogeneous materials for this part is below the limit requirements in SJ/T11363-2006

X: 该有毒有害物质至少在该部件的某一均质材料中的含量超出SJ/T11363-2006标准规定的限量要求。

X: Indicates that this toxic or hazardous substance contained in at least one of the homogeneous materials used for this part is above the limit requirements in SJ/T11363-2006



表的有毒有害物质

Table of Toxic and Hazardous Substances

部件名称 Names of Parts	有毒有害物质或元素 Toxic and Hazardous Substances or Elements					
	铅 Pb	镉 Cd	汞 Hg	六价铬 Cr6+	多溴联苯 PBB	多溴二苯醚 PBDE
WH220 头戴式耳麦 Top Assembly WH220 (G28741-1Z1)	X	O	O	O	O	O
耳机电路板 PCB (G28055-1F1)	X	O	O	O	O	O
电池 Battery (104034)	O	O	O	O	O	O

O: 表示该有毒有害物质在该部件所有均质材料中的含量均在SJ/T11363-2006标准规定的限量要求以下。  
O: Indicates that this toxic or hazardous substance contained in all of the homogeneous materials for this part is below the limit requirements in SJ/T11363-2006

X: 该有毒有害物质至少在该部件的某一均质材料中的含量超出SJ/T11363-2006标准规定的限量要求。  
X: Indicates that this toxic or hazardous substance contained in at least one of the homogeneous materials used for this part is above the limit requirements in SJ/T11363-2006